

REF.No.1006514
Code FO :9008002141
Version :2023/03/10

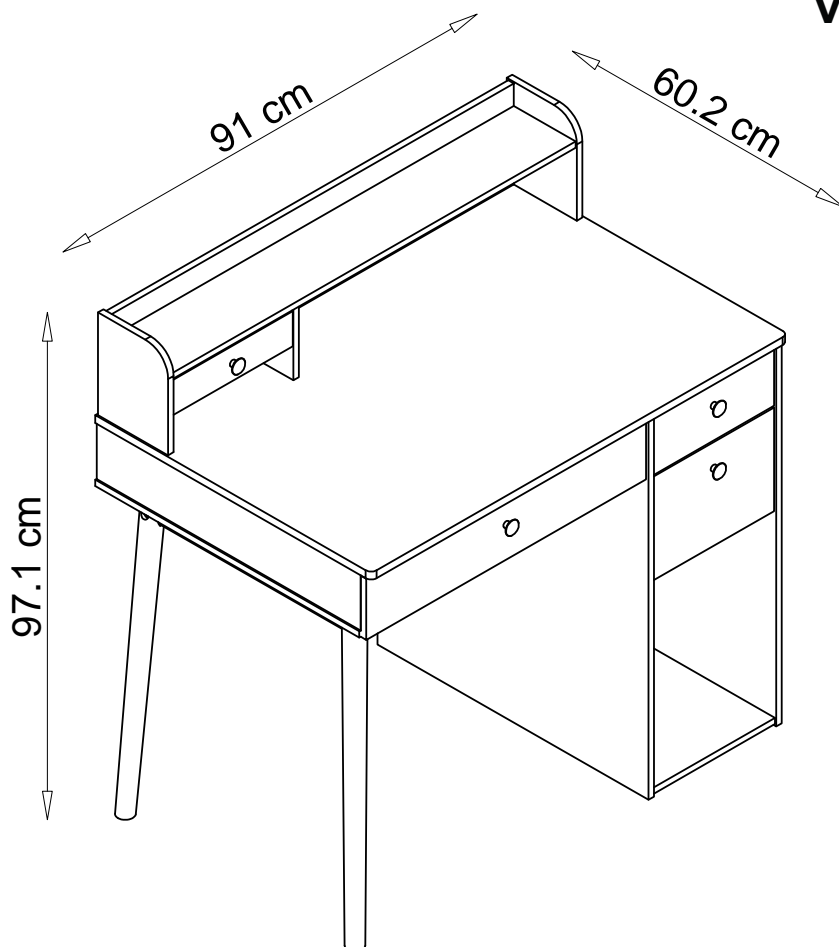

- De Inhoud van uw pakket controleren alvorens met de montage te beginnen
- De Verpakking niet beschadigen, deze kan heel handig zijn om de onderdelen te beschermen tegen schokken en krassen tijdens de montage.
- Zet vervolgens het meubel in elkaar in de volgorde die is bepaald in de nummering
- Neem bij problemen contact op met onze klantenservice.
- Laat na ontvangst uw meubels luchten (deuren en laden open) in een goed geventileerde ruimte. Zorg regelmatig voor frisse lucht in uw kamer



- Contrôler le contenu de votre colis avant de procéder au montage.
- Ne détériorez pas l'emballage, il vous sera très utile pour protéger les éléments des coups et rayures pendant le montage.
- Assemblez ensuite le meuble en suivant l'ordre défini par la numérotation.
- En cas de problème contactez notre service après vente.
- A réception, aérer vos meubles, portes et tiroirs ouverts, dans une pièce bien ventilée. Renouveler régulièrement l'air de vos pièces.



- Check the content of your parcel before assembling.
- Do not throw away the packing which could be very useful to protect the panels from knocks and scratches when assembling.
- Assemble the article following the order of the numbers indicated.
- Should any problems arise, please contact our After Sale Service.
- Upon receipt, place the furniture in a well-ventilated room and leave doors and drawers open to allow the air to circulate. Change the air in your rooms on a regular basis.



- Confira o conteúdo da sua encomenda antes de iniciar a montagem.
- Não danifique a embalagem, poderá ser-lhe útil para proteger os elementos de golpes ou riscos durante a montagem.
- Proceda à montagem do móvel seguindo a ordem definida pela numeração.
- Para qualquer esclarecimento, contacte os nossos serviços através do telefone.
- Quando da sua recepção, arejar os seus móveis, portas e gavetas abertas, numa divisão bem ventilada. Renovar regularmente o ar das suas divisões.



- Vor Montage den Inhalt Ihres Päckchens kontrollieren
- Die Verpackung nicht zerstören, sie wird Ihnen nützlich sein, um die Teile bei der Montage vor Stößen und Kratzern zu schützen
- Das Möbel dann in der Reihenfolge der Nummerierung zusammenbauen
- Im Problemfall Ihren Kundendienst anrufen
- Lüften Sie Ihre Möbel nach dem Aufbau bitte mit geöffneten Möbeltüren und-schubladen in einem gut durchlüfteten Raum.



- Controlar el contenido de su embalaje antes de proceder al montaje
- No deteriorar el paquete, que le será muy útil para proteger los elementos de golpes y rozaduras durante el montaje.
- Acoplar de seguida el mueble, siguiendo la orden definida por la numeración
- Si tiene problemas, contactar nuestro servicio postventa
- Desde la recepción, ventilar los muebles, con las puertas y cajones abiertos, en una estancia bien ventilada. Renovar regularmente el aire de las estancias



- Verificare il contenuto della confezione prima del montaggio.
- Non eliminare l'imballo che potrà essere utilizzato per proteggere il prodotto dai danni durante il montaggio.
- Montare l'articolo seguendo l'ordine di numerazione.
- In caso di necessità contattare il nostro servizio post-vendita.
- Al ricevimento, areare i vostri mobili, aprendo porte e cassetti, in una stanza ben ventilata. Ricambiare l'aria della stanza regolarmente

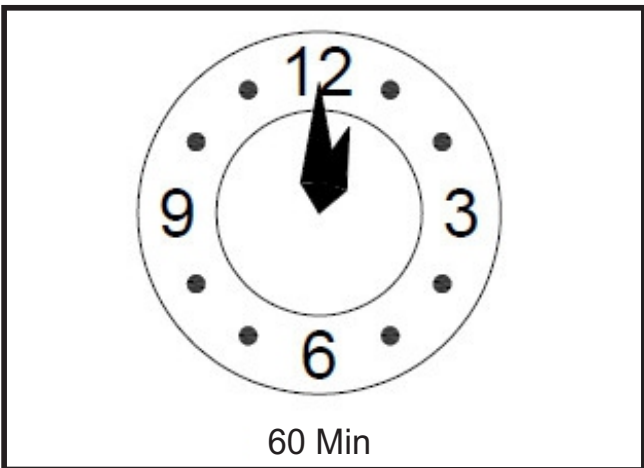
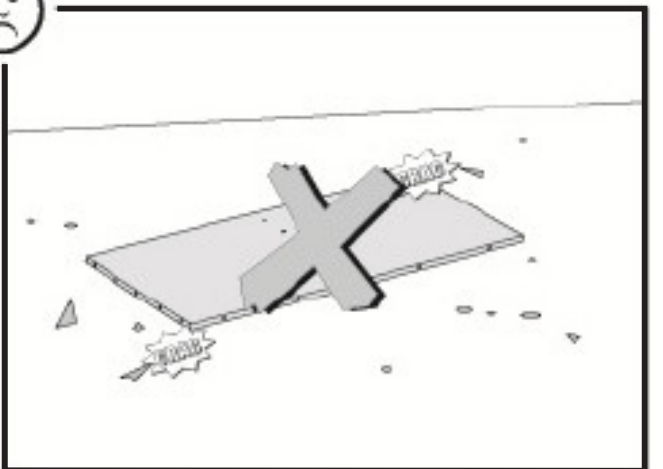
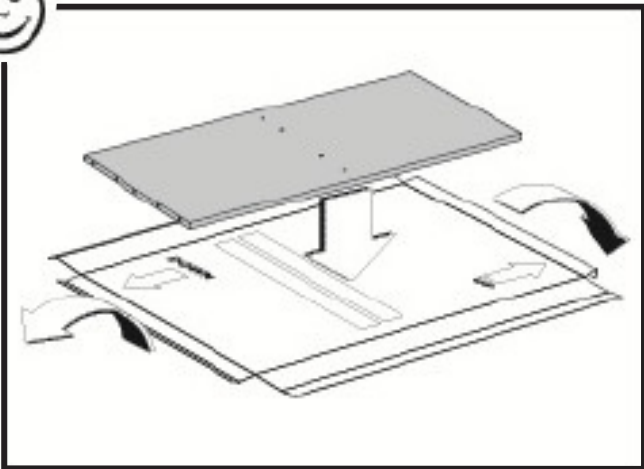
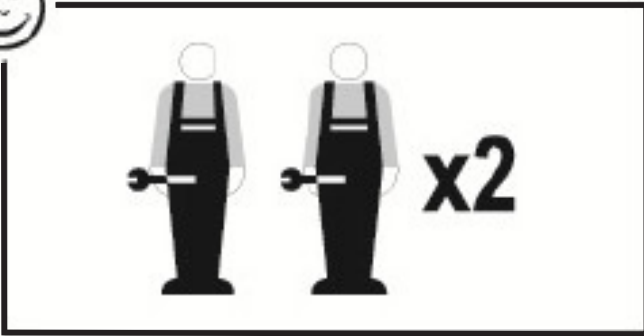
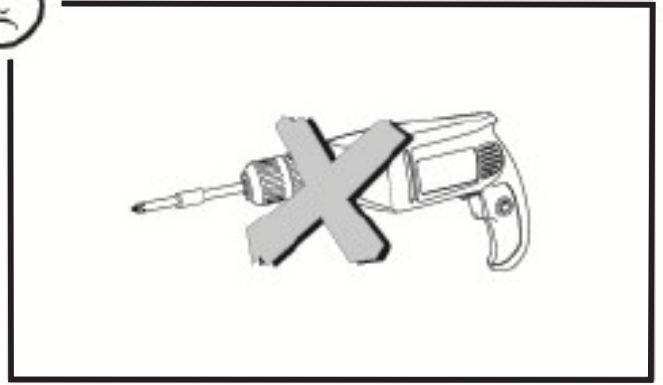
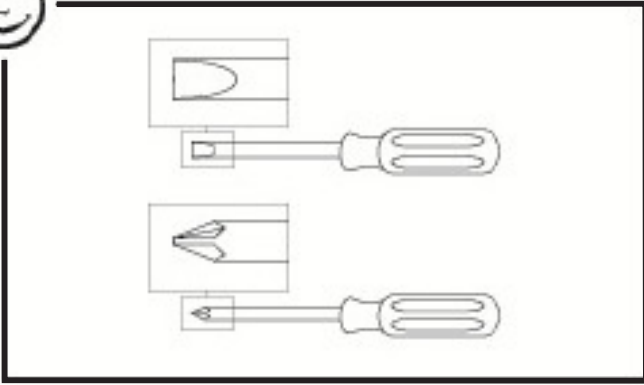

**FR - Notice de montage / EN - Assembly instructions / PT - Instruções de montagem /
ES - Prospecto de montaje / DE - Montageanleitung / IT - Istruzioni di montaggio /
NL - Montagehandleiding**

FR – IMPORTANT! CONSERVER POUR CONSULTATION ULTERIEURE: LIRE ATTENTIVEMENT

- A monter par un adulte. Un adulte doit vérifier le bon assemblage avant l'emploi
- ATTENTION! tenir les vis et petits éléments et sachets hors de portée des enfants
- Bien identifier les éléments avant de commencer le montage
- Ne pas utiliser votre article lorsque l'un de ses éléments est cassé ou manquant
- En cas de problème contactez notre service après-vente
- Toujours suivre les instructions du fabricant
- Ne pas monter sur le produit
- Ne pas s'asseoir sur le bureau
- Entretien: nettoyer avec un chiffon doux et sec. En cas de taches plus grosses, frottez soigneusement avec une éponge légèrement humide et non abrasive
- ATTENTION! Ne convient pas aux enfants de moins de 3 ans. Petits éléments. Danger d'étouffement.

EN – IMPORTANT! KEEP FOR FUTURE REFERENCE: READ CAREFULLY

- To be assembled by an adult. Assembly must be checked by an adult before use
- WARNING! keep all screws, small parts and plastic bags out of the reach of children
- Properly identify all parts before assembling
- Never use your item if any of its parts are broken or missing
- Should any problems arise, please contact our After Sales Service
- Manufacturer's instructions shall be followed at all times
- Do not climb on this product
- Do not sit on the desk
- Care: clean with a soft, dry cloth. In case of larger stains, carefully rub with a slightly damp, non-abrasive sponge
- WARNING! Not suitable for children under 3 years. Small parts. Choking hazard.

PT – IMPORTANTE! GARDE PARA CONSULTA POSTERIOR: LER ESTAS INSTRUÇÕES CUIDADOSAMENTE

- A ser montado por um adulto. Um adulto deve verificar a boa montagem antes da utilização
- ATENÇÃO! mantenha os parafusos, acessórios pequenos e saco de plástico fora do alcance das crianças
- Identifique bem os acessórios antes de começar a montagem
- Não utilizar o artigo se um dos elementos está em falta ou danificado
- Para qualquer esclarecimento, contacte os nossos serviços através do telefone
- As instruções do fabricante devem ser sempre cumpridas
- Não suba para cima do produto
- Não se sentar na secretária
- Manutenção: limpe com um pano macio e seco. Em caso de manchas maiores, esfregue cuidadosamente com uma esponja ligeiramente húmida e não abrasiva
- ATENÇÃO! Não destinado a crianças menores de três anos. Peças pequenas. Risco de sufocamento.

ES – IMPORTANTE! CONSERVAR PARA FUTURAS CONSULTAS: LEER DETENIDAMENTE

- A montar por un adulto. Un adulto debe comprobar el buen montaje antes de la utilización
- ¡ADVERTENCIA! mantener los tornillos, los pequeños elementos y bolsitas fuera del alcance de los niños
- Identificar debidamente los elementos antes de empezar el montaje
- No utilizar este artículo si uno de los elementos falta o esta roto

- Si tiene problemas, contactar nuestro servicio postventa
- Deben seguirse siempre las instrucciones del fabricante
- No subir sobre el producto
- No sentarse en el escritorio
- Cuidados: limpiar con un paño suave y seco. En caso de manchas grandes, frotar con cuidado utilizando una esponja húmeda no abrasiva
- ¡ADVERTENCIA! No conveniente para niños menores de 3 años. Piezas pequeñas. Riesgo de asfixia.

DE – WICHTIG! FÜR SPÄTERE BEZUGNAHME AUFBEWAHREN: SORGFÄLTIG LESEN

- Von einem Erwachsenen zu montieren. Die korrekte Montage muss vor Gebrauch von einem Erwachsenen geprüft werden
- ACHTUNG! die Schrauben und kleinen Teile ausserhalb der Reichweite von Kindern lagern
- Vor Montagebeginn alle Teile identifizieren
- Ihren Artikel nicht benutzen, wenn eines seiner Bestandteile beschädigt ist oder fehlt
- Im Problemfall Ihren Kundendienst anrufen
- Stets die Herstelleranweisungen beachten
- Nicht auf das Produkt steigen
- Nicht auf den Schreibtisch setzen
- Wartung: Mit einem weichen, trockenen Tuch reinigen. Bei größeren Flecken vorsichtig mit einem leicht feuchten, nicht scheuernden Schwamm abreiben
- ACHTUNG! Nicht für Kinder unter 3 Jahren. Kleine Teile. Erstickungsgefahr.

IT - IMPORTANTE! CONSERVARE QUESTE INFORMAZIONI PER ULTERIORI CONSULTAZIONI: LEGGI ATTENTAMENTE

- Il montaggio deve essere eseguito da un adulto. Un adulto dovrà verificare il corretto montaggio prima dell'uso
- ATTENZIONE! tenere le viti ed i componenti di piccole dimensioni lontano dalla portata dei bambini
- Controllare i pezzi prima del montaggio
- L'articolo non deve essere utilizzato in caso di elementi mancanti o danneggiati
- In caso di necessità contattare il nostro servizio post-vendita
- Seguire sempre le istruzioni del costruttore
- Non salire sul prodotto
- Non sedersi sulla scrivania
- Manutenzione: pulire con un panno morbido e asciutto. Per le macchine più grandi, strofinare accuratamente con una spugna leggermente umida e non abrasiva
- ATTENZIONE! Non adatto a bambini di età inferiore a 3 anni. Piccoli pezzi. Rischio di soffocamento.

NL - BELANGRIJK! BEWAAR VOOR LATERE RAADPLEGING: LEES AANDACHTIG



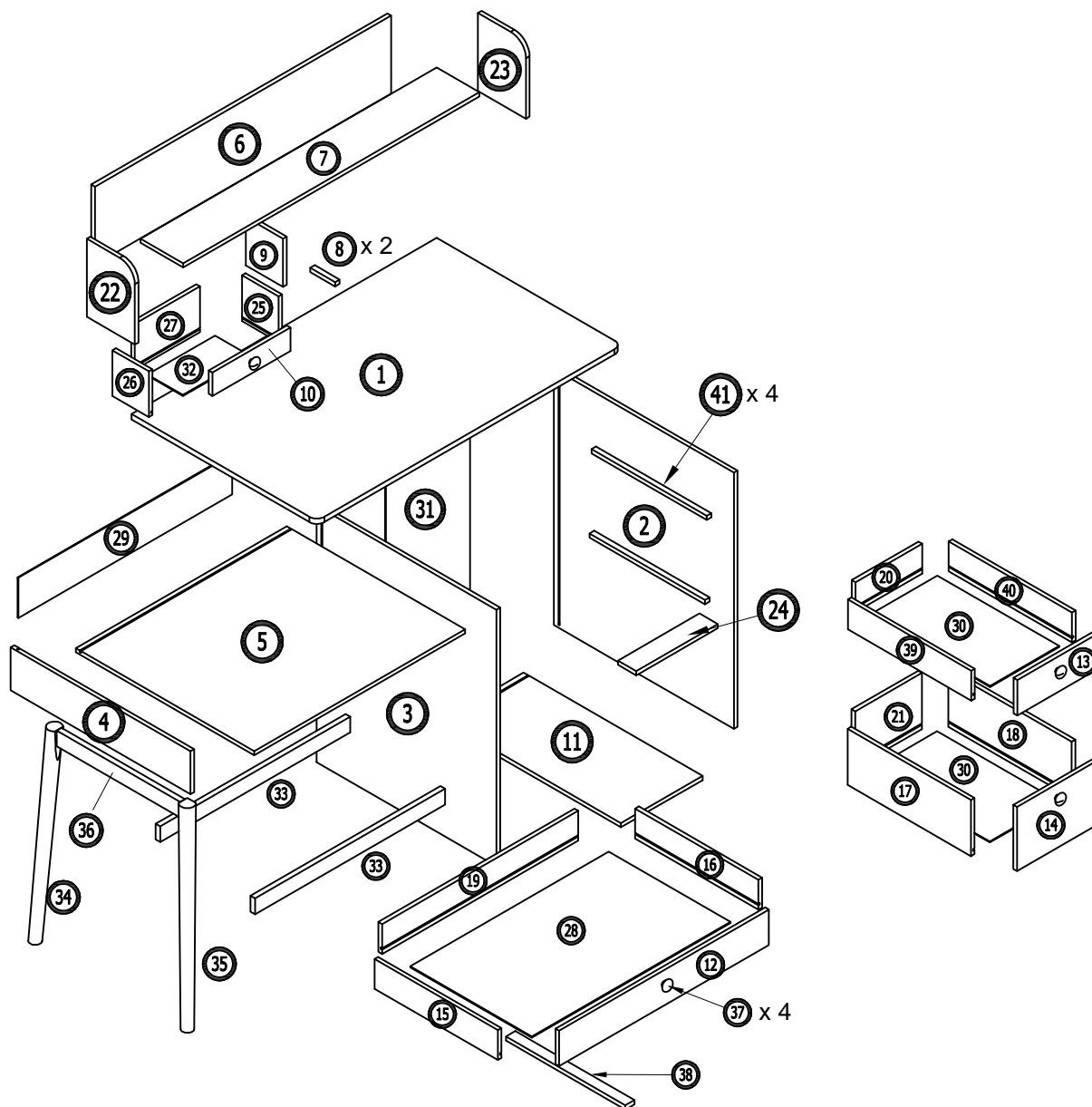

- Moet door een volwassene worden gemonteerd. Voor gebruik moet een volwassene controleren dat het product goed in elkaar is gezet
- WAARSCHUWING! schroeven en kleine elementen en zakjes buiten bereik van kinderen houden
- De elementen goed identificeren alvorens met de montage te beginnen
- Uw artikel niet gebruiken wanneer een van de onderdelen kapot is of ontbreekt
- Neem bij problemen contact op met onze klantenservice
- Volg altijd de instructies van de fabrikant
- Niet op het product klimmen
- Zit niet op het bureau
- Onderhoud: maak schoon met een zachte en droge doek. In geval van grotere vlekken, veeg voorzichtig schoon met een licht bevochtigde en niet-schurende spons
- WAARSCHUWING! Is niet geschikt voor kinderen van jonger dan 3 jaar. Kleine onderdelen. Verstikkingsgevaar.



ITEM	HARDWARE	DESCRIPTION	Q'TY
A		Ø4.5 x 35 mm	33 PCS
B		Ø14.5x9.5mm	33 PCS
C		Ø6x30 mm	38 PCS
D		TF Ø4 X 25 mm	4 PCS
E		TF Ø4 x 30mm	29 PCS
F		Ø3.6 x 11 mm	10 PCS
G		TF Ø3.5 x 15 mm	11 PCS
H		L = 300 mm	2 PCS
J		L = 300 mm	2 PCS
K			8 PCS

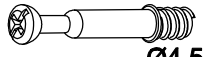

ITEM	HARDWARE	DESCRIPTION	Q'TY
L			3 PCS
M		Ø8 x 30 mm	6 PCS
N		Ø4 x 20mm	16 PCS
O		Ø9.5 x 11 mm	6 PCS
P		Ø6 x 80 mm	6 PCS
Q		Ø4 x 40mm	8 PCS
U		30x12x2 mm	4 PCS
S		20x20x2 mm	2 PCS

1

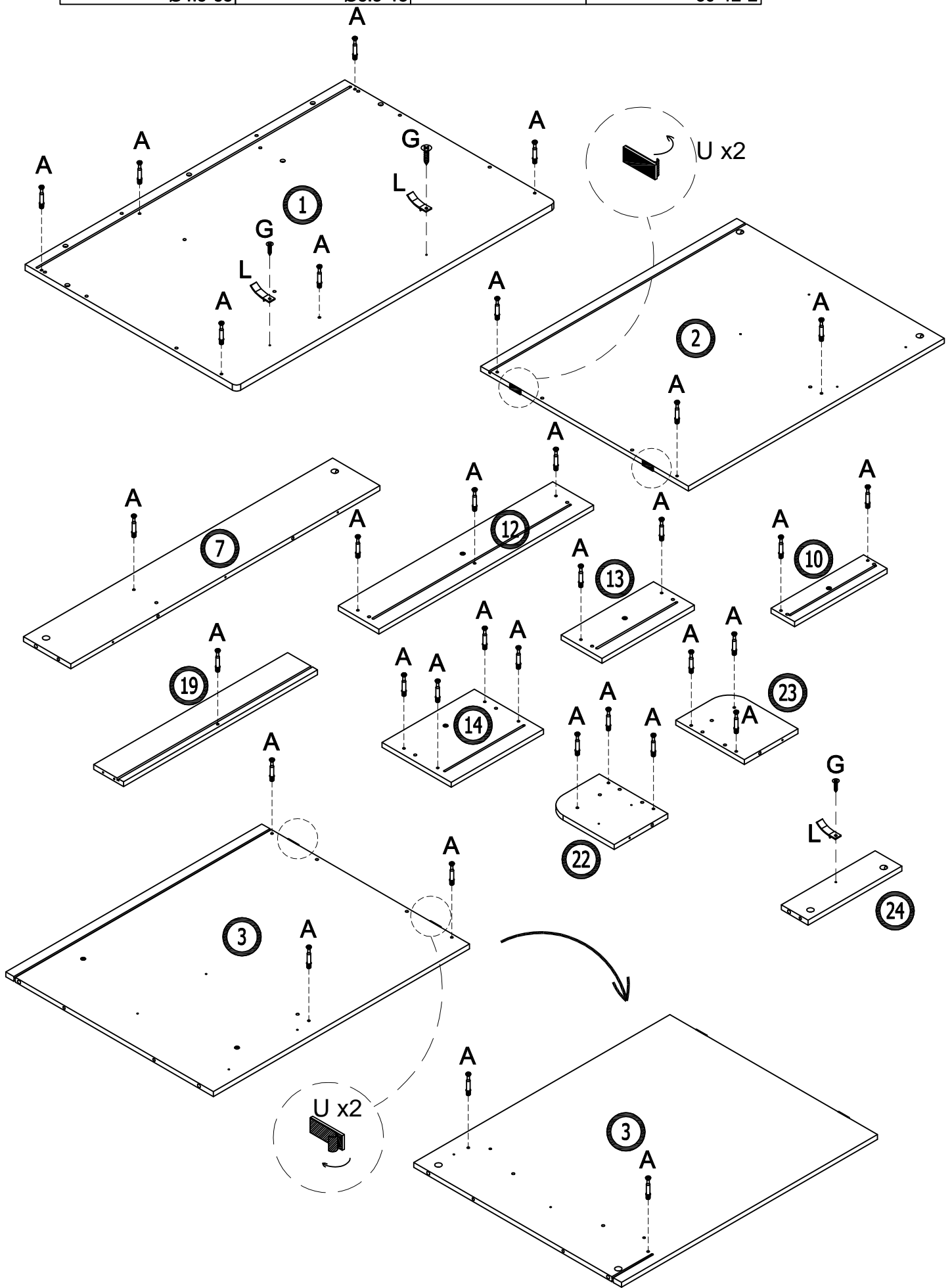

A	x 33	G	x 3	L	x 3	U	x 4
							
Ø4.5*35		Ø3.5*15				30*12*2	

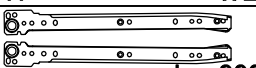

2

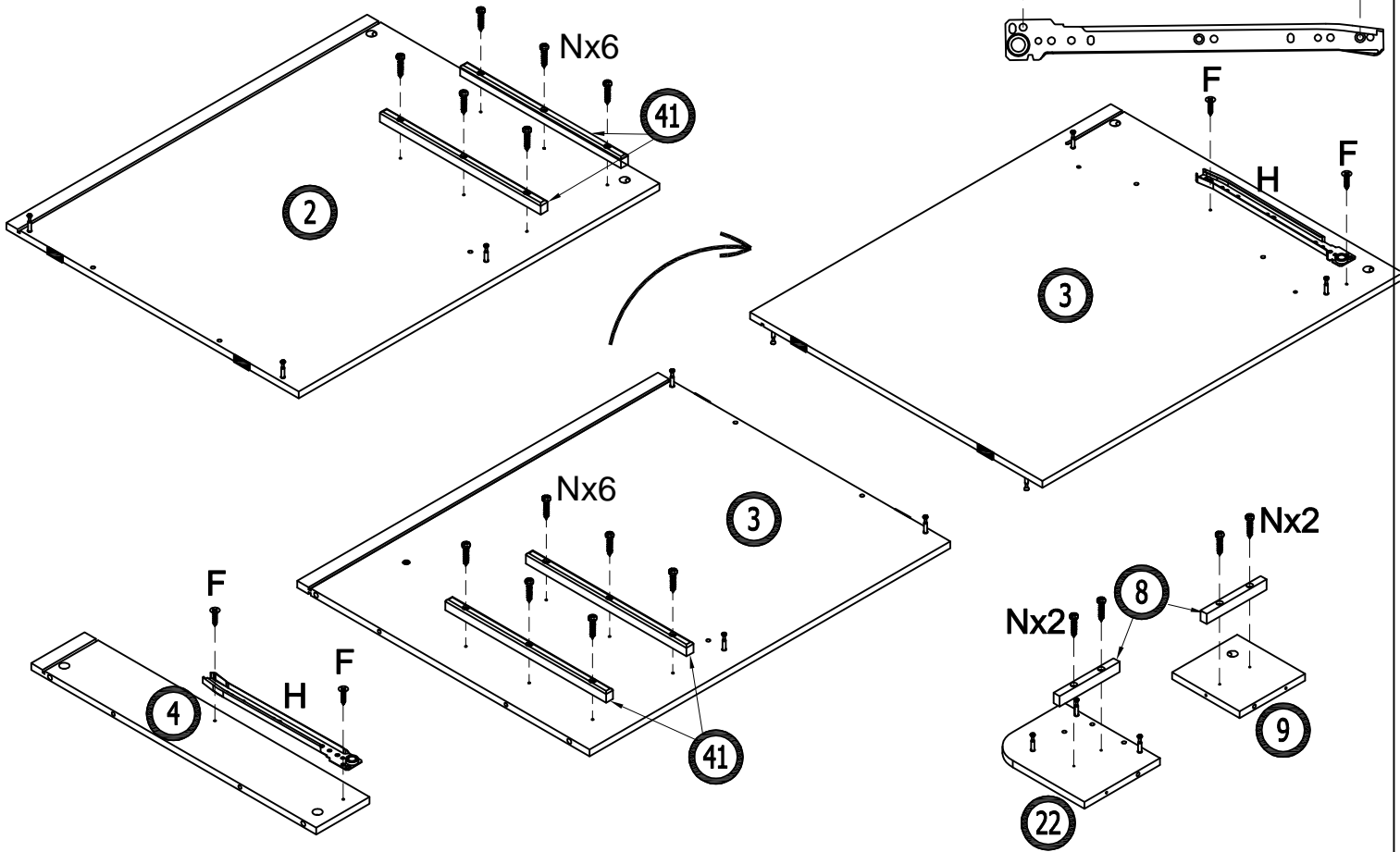

F	x 4	H	x 2	N	x 16
					
	Ø3.6*11		L = 300		Ø4*20

**3**

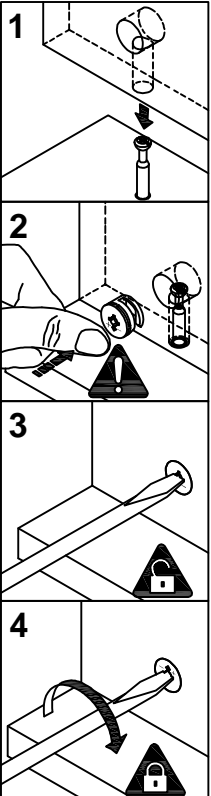
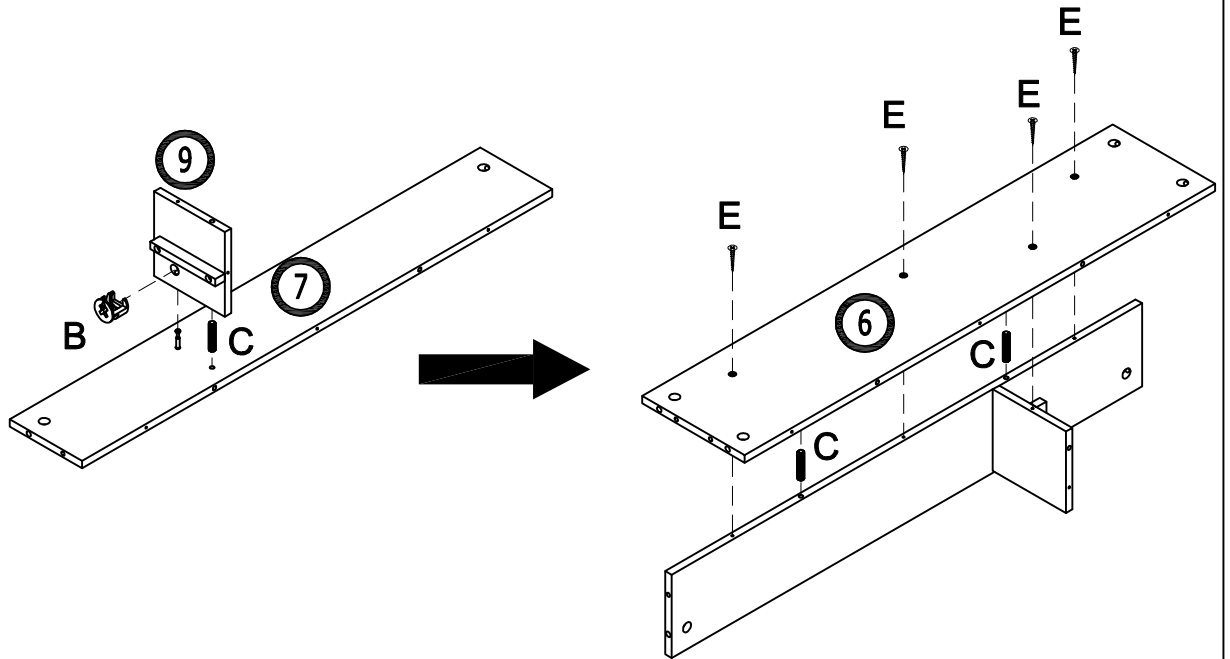
B	x 1	C	x 3	E	x 4
					
	Ø14.5*9.5		Ø6*30		Ø4*30



4

B	x 6	C	x 6
			
	Ø14.5*9.5		Ø6*30

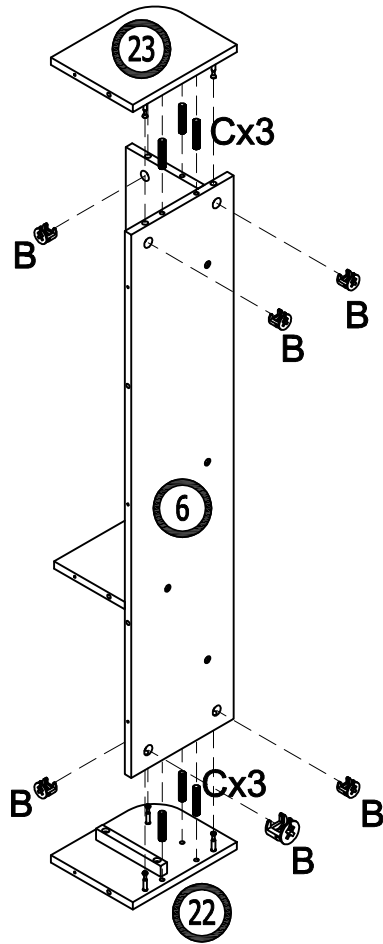
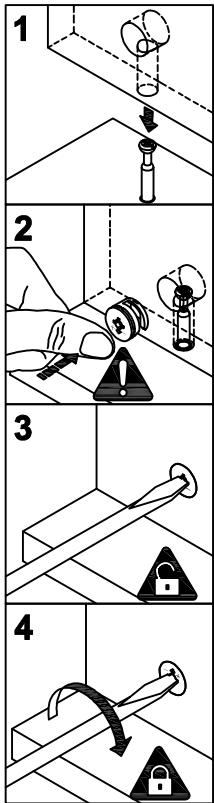



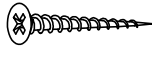

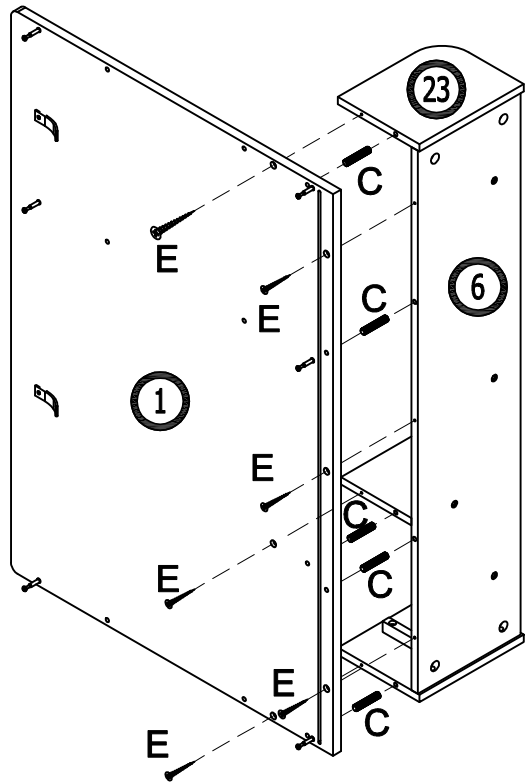
5

C	x 5	E	x 6
			
	Ø6*30		Ø4*30



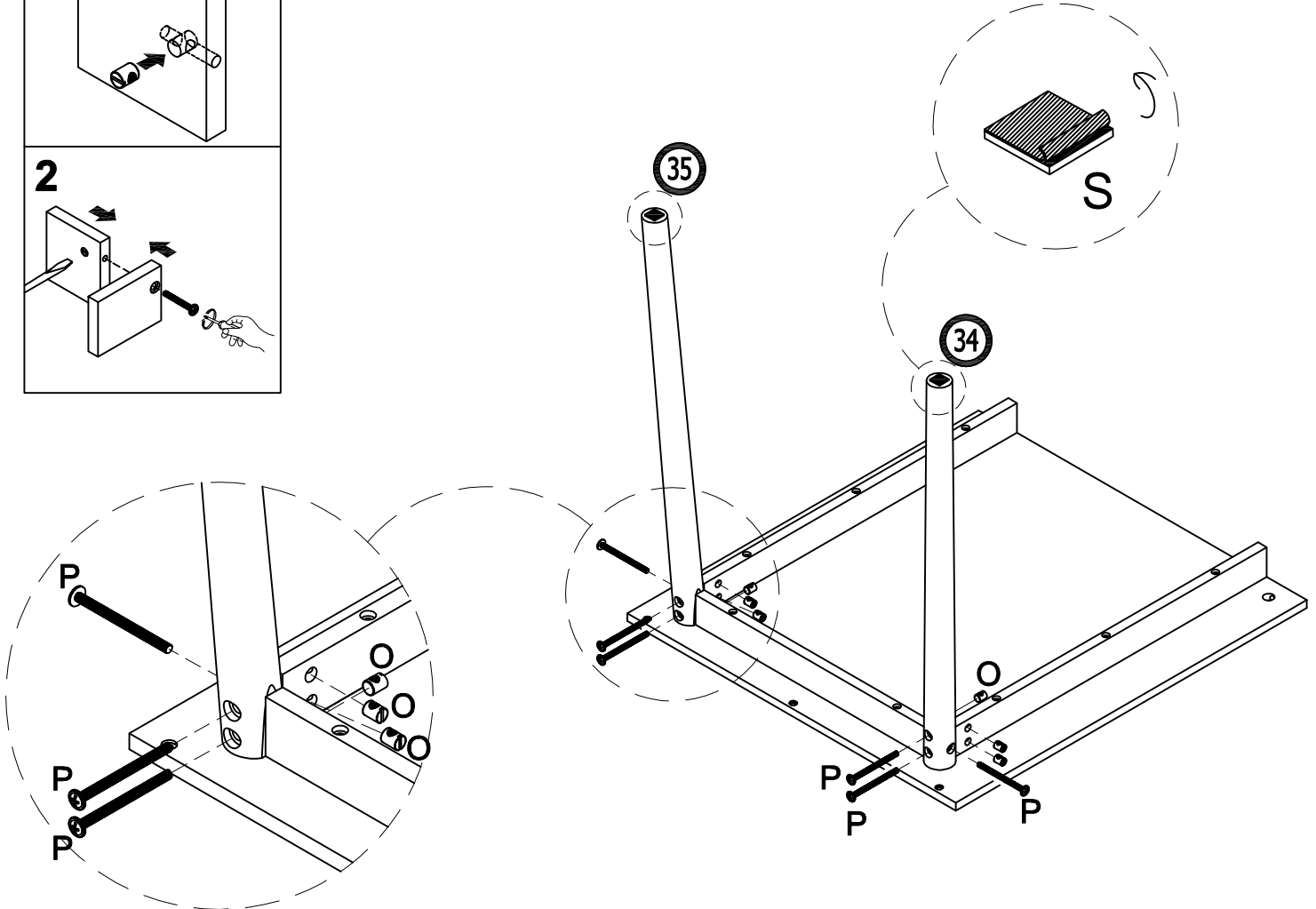
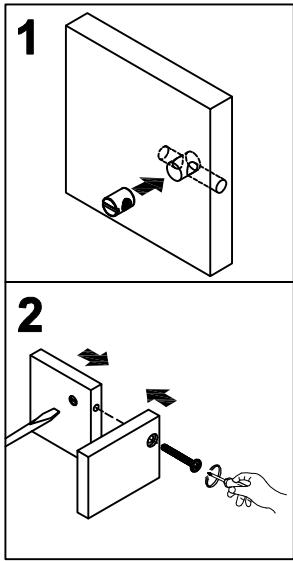
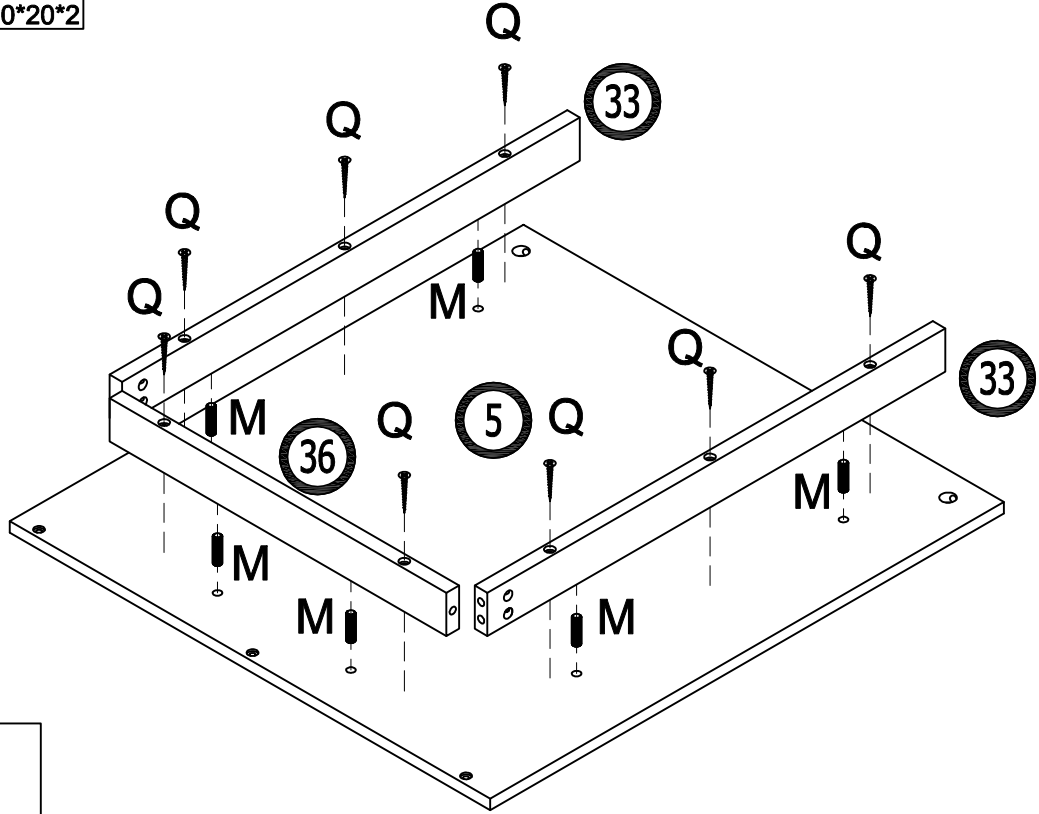

6

M	x 6	O	x 6	P	x 6	Q	x 8
							
Ø8*30		Ø9.5*11		Ø6*80		Ø4*40	
S	x 2						
							
20*20*2							



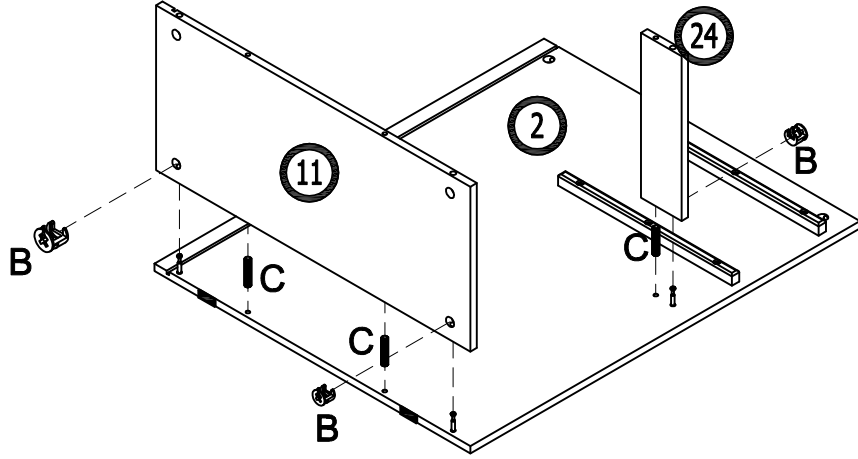
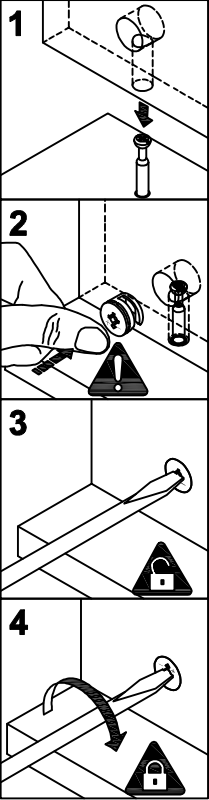

7

B	x 3	C	x 3
			
Ø14.5*9.5		Ø6*30	



8

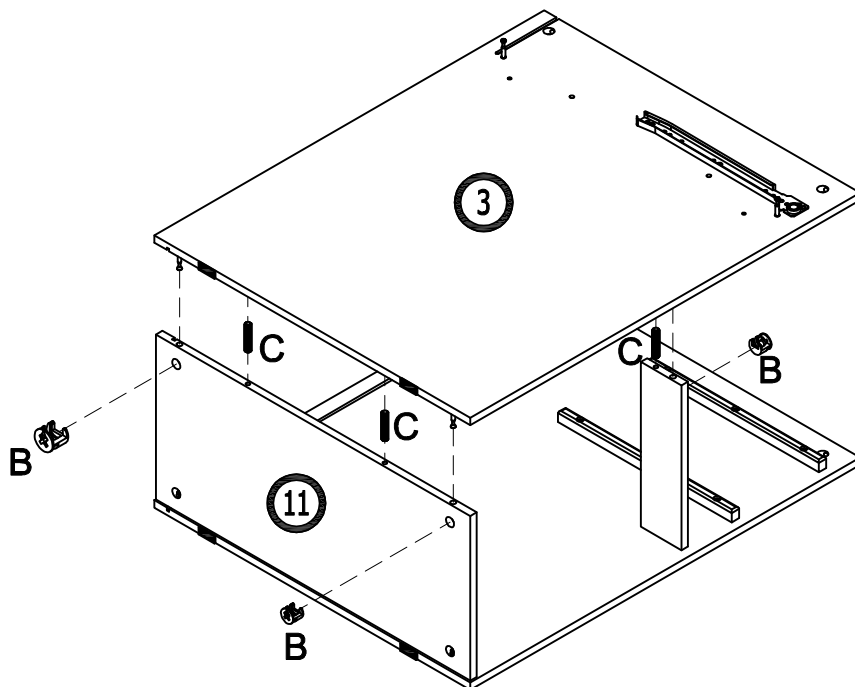
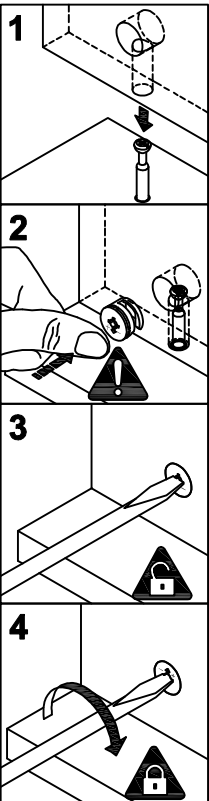

B	x 3	C	x 3
			
Ø14.5*9.5		Ø6*30	

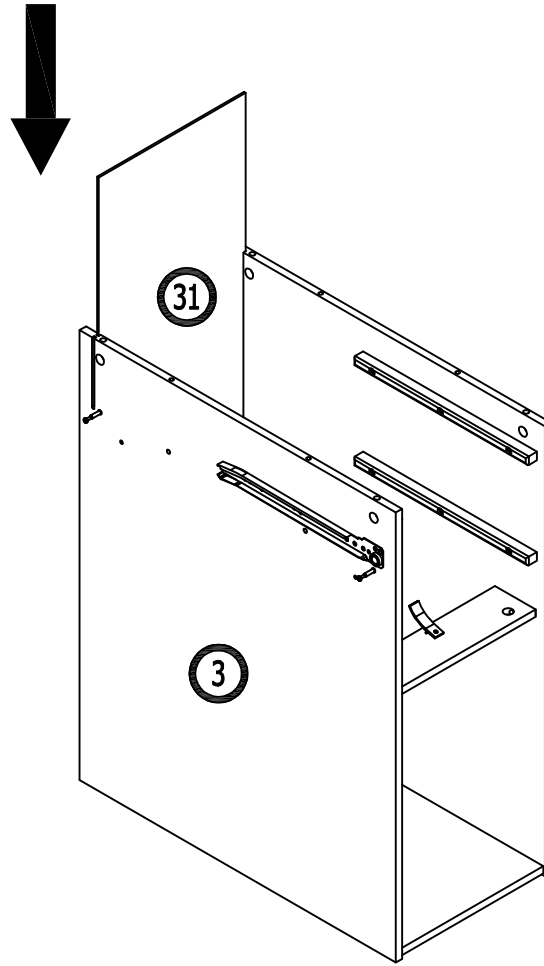

9



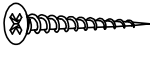

10

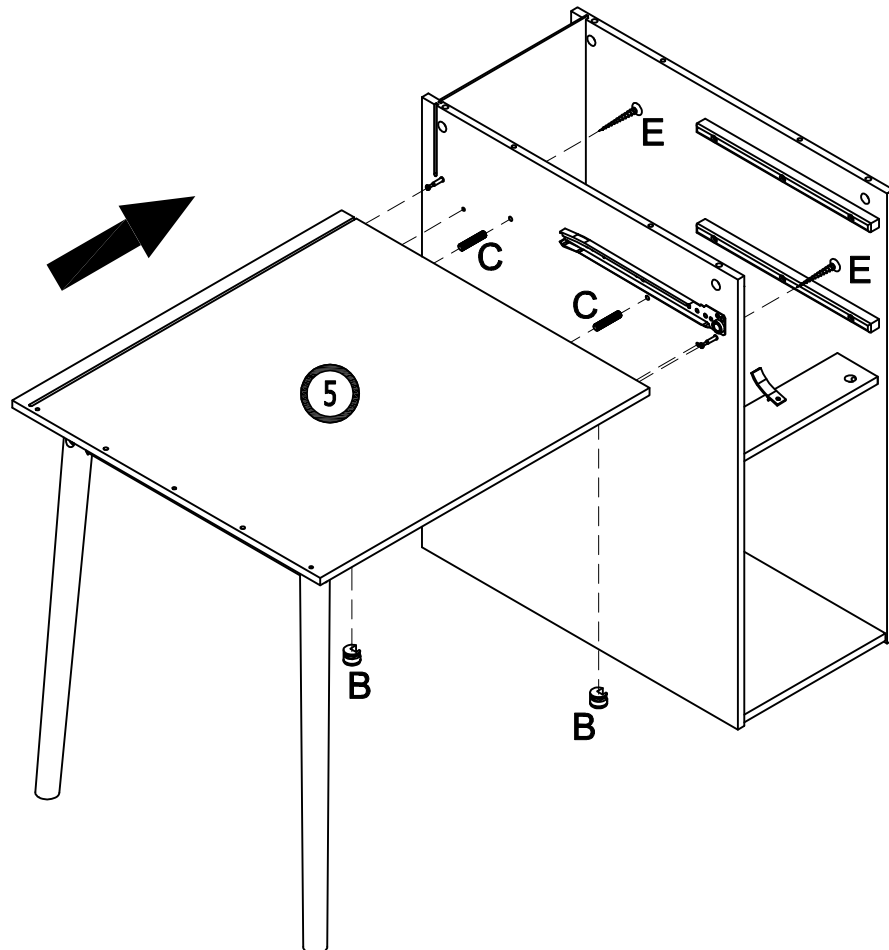
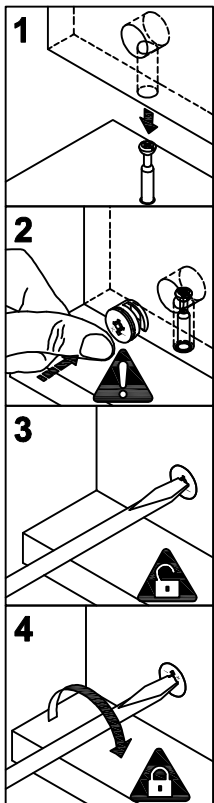
B	x2	C	x2	E	x2
					
Ø14.5*9.5		Ø6*30		Ø4*30	



11

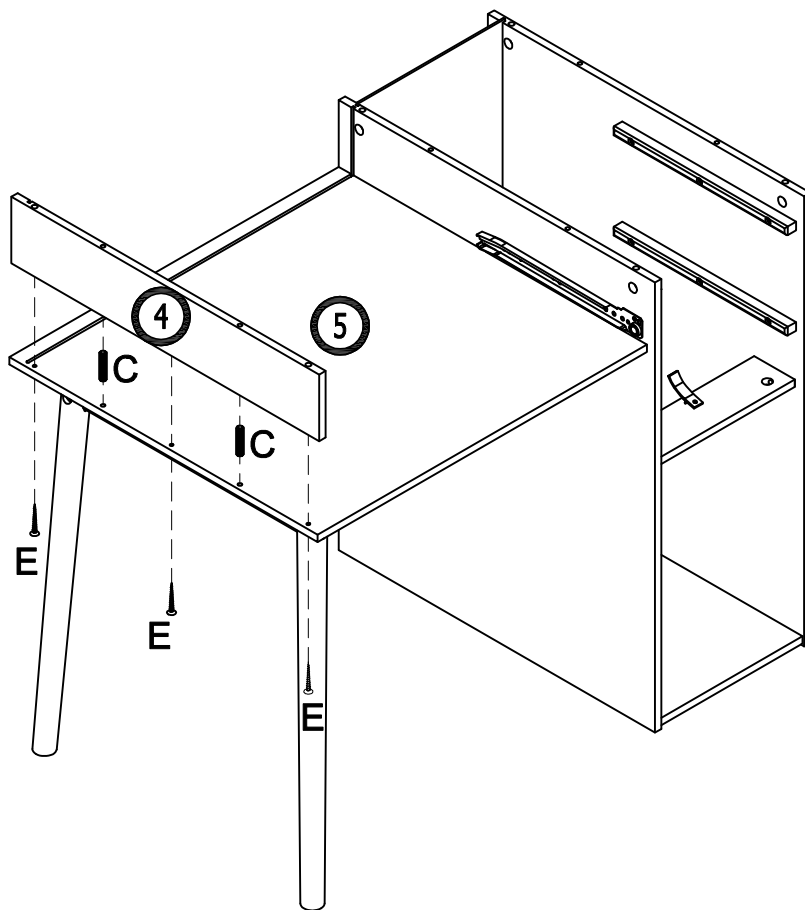
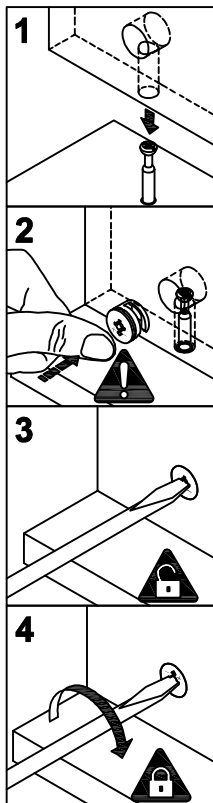

C	x 2	E	x 3
			
	Ø6*30		Ø4*30

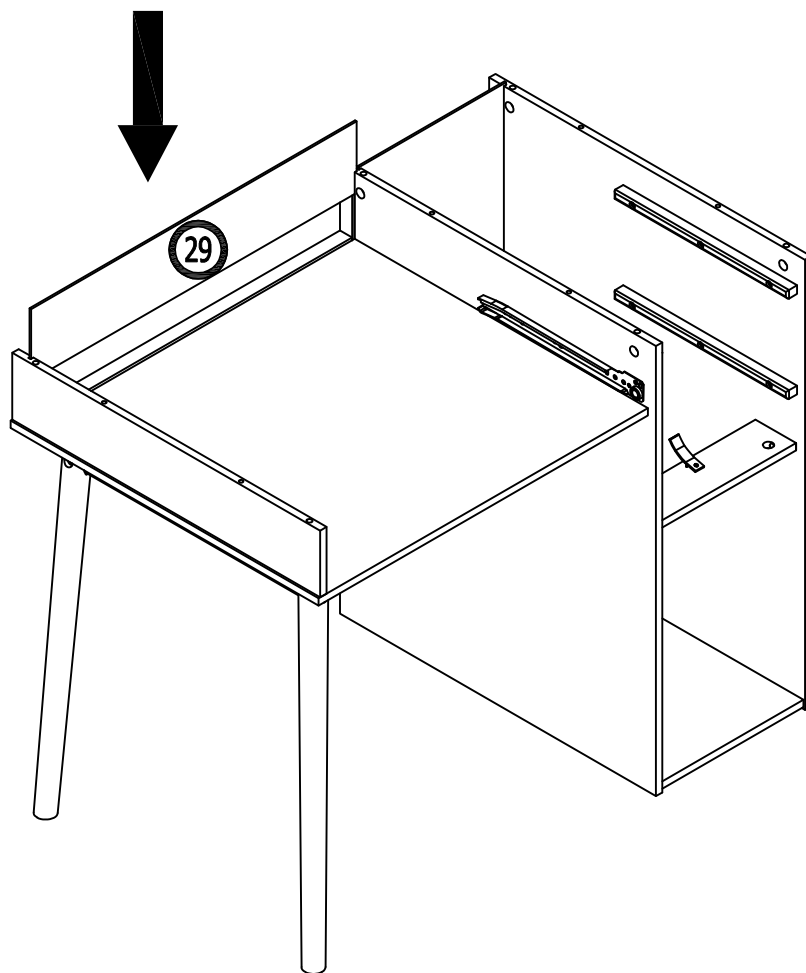

12



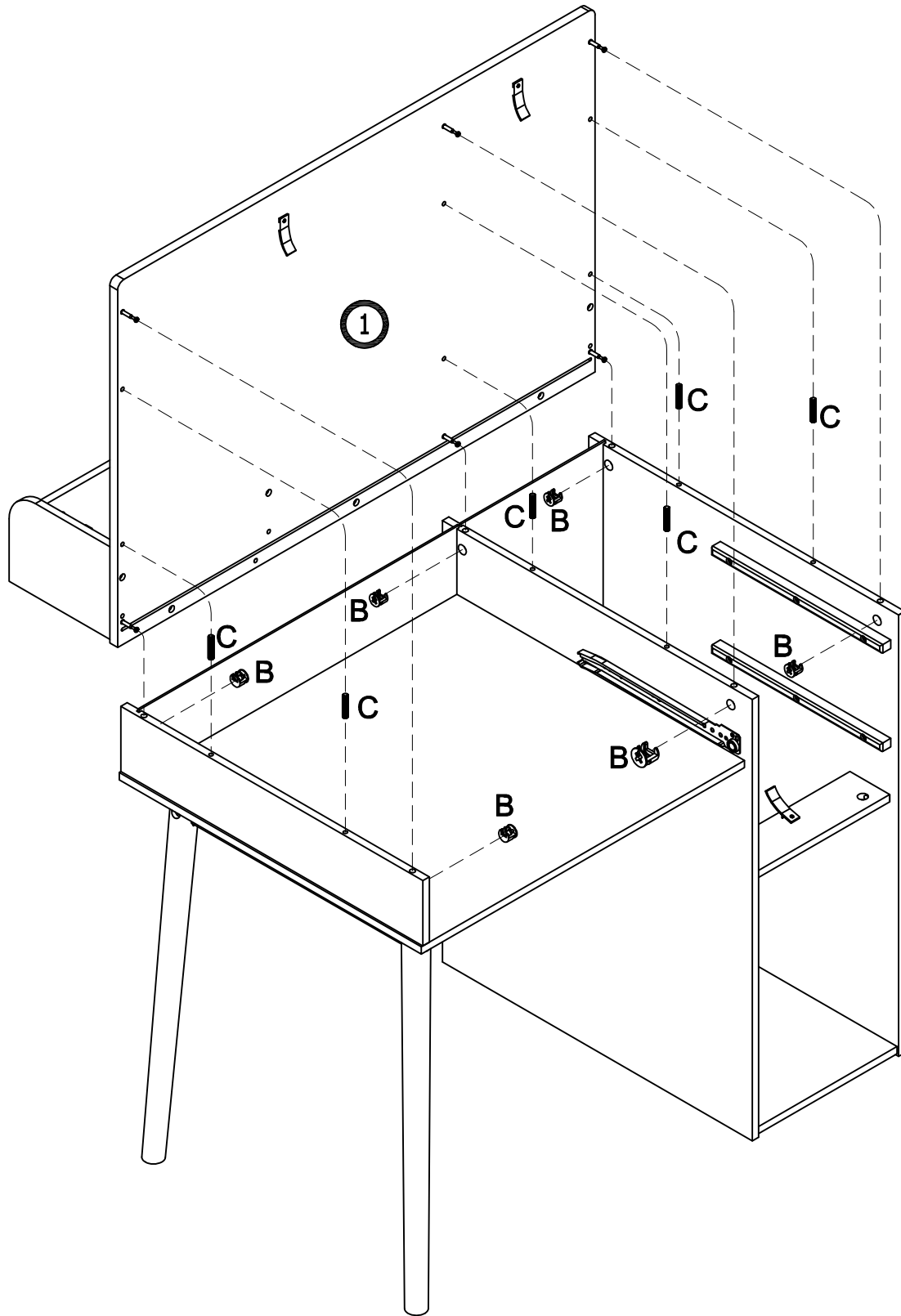
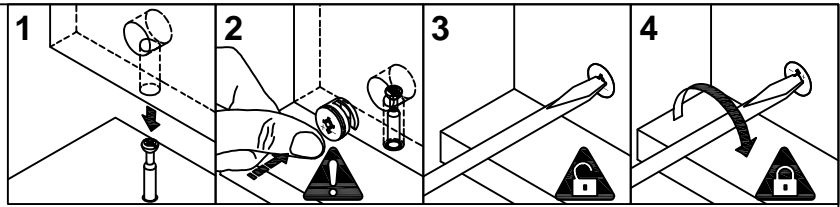

13

B	x6	C	x6
			
Ø14.5*9.5		Ø6*30	





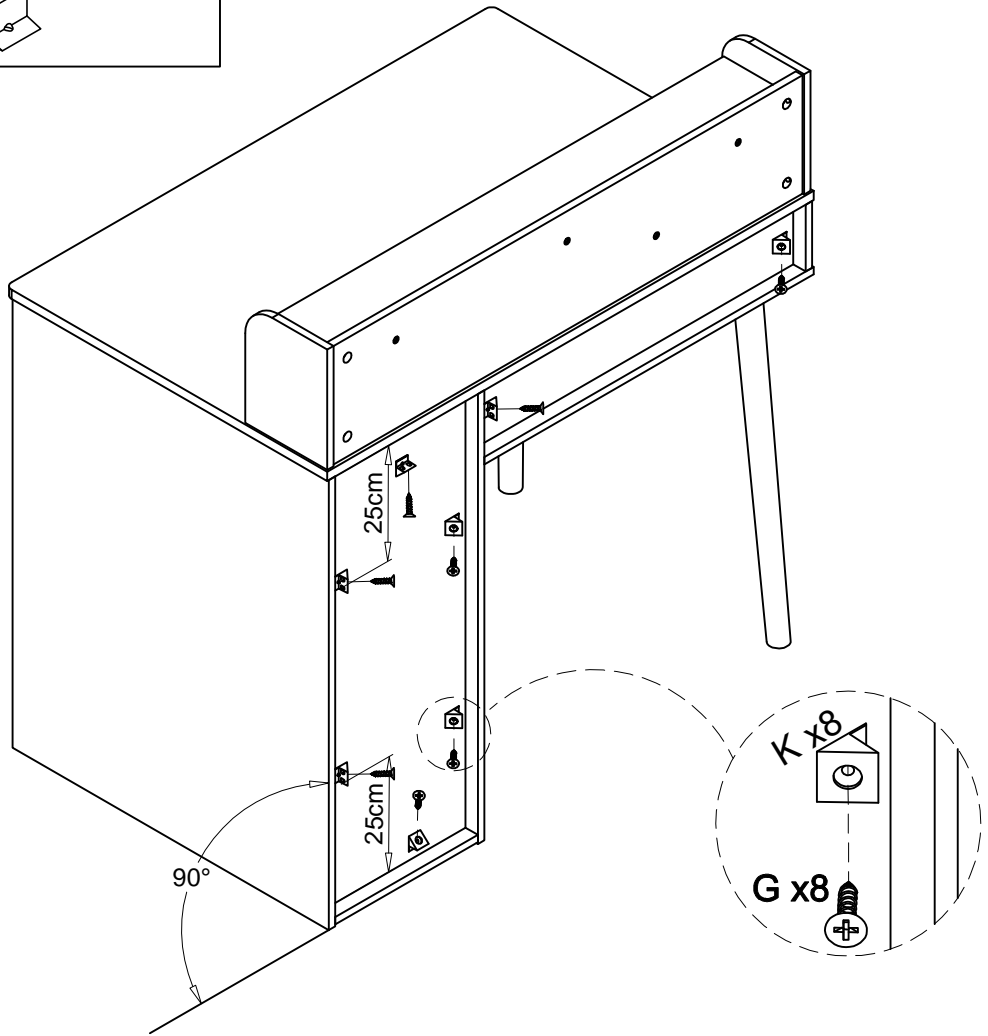

14

G	x 8	K	x 8
			
Ø3.5*15			

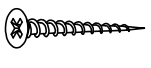

15

B	x 2	C	x 2	D	x 1	E	x 2
							
Ø14.5*9.5		Ø6*30		Ø4*25		Ø4*30	

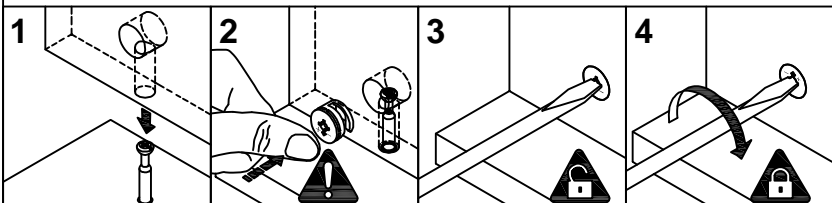
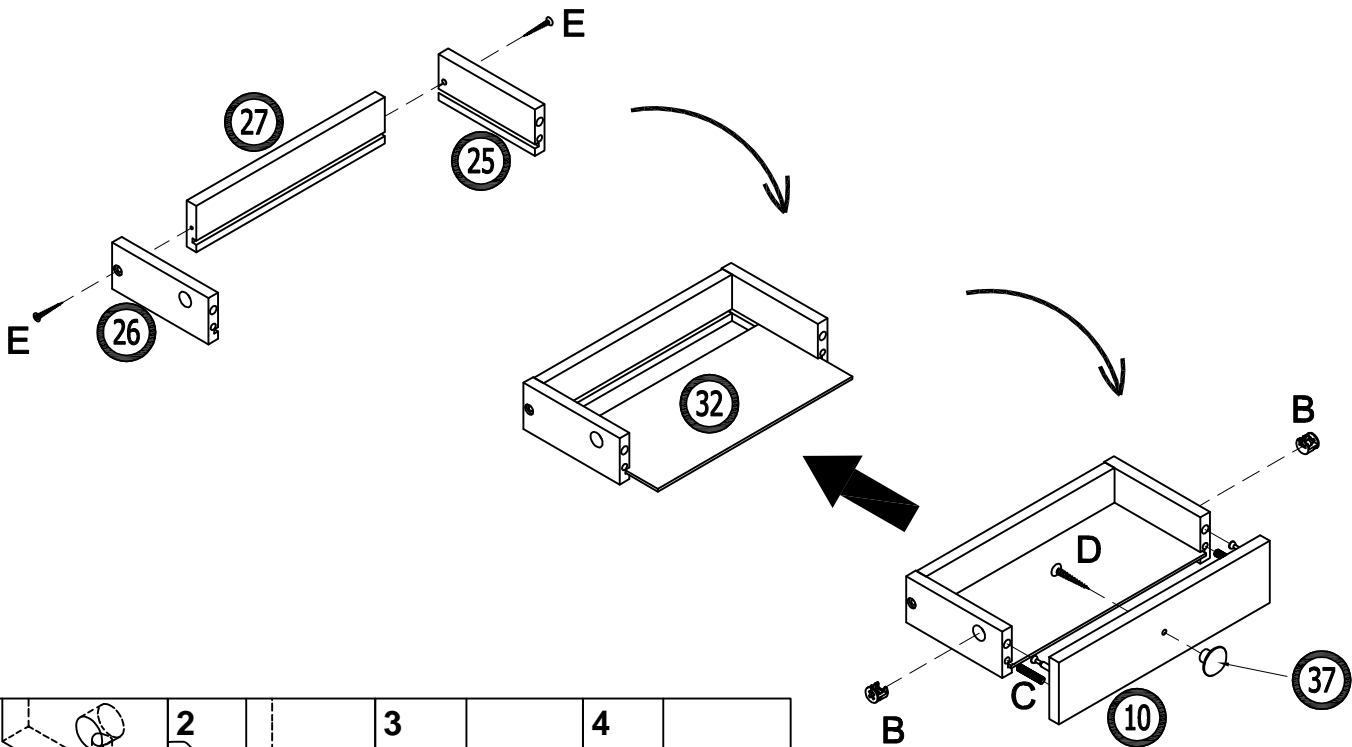



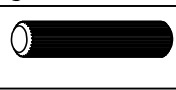
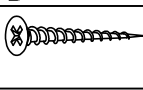
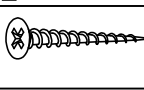
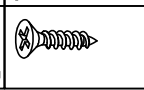
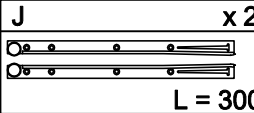

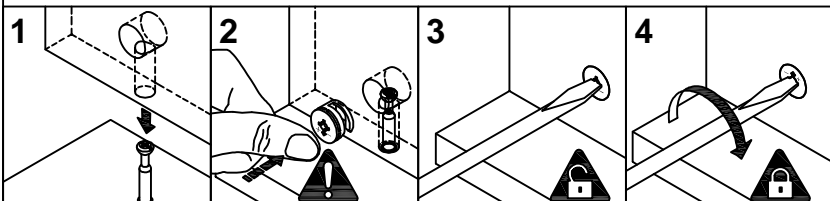
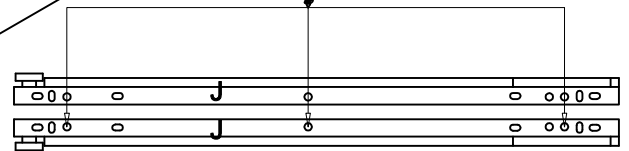
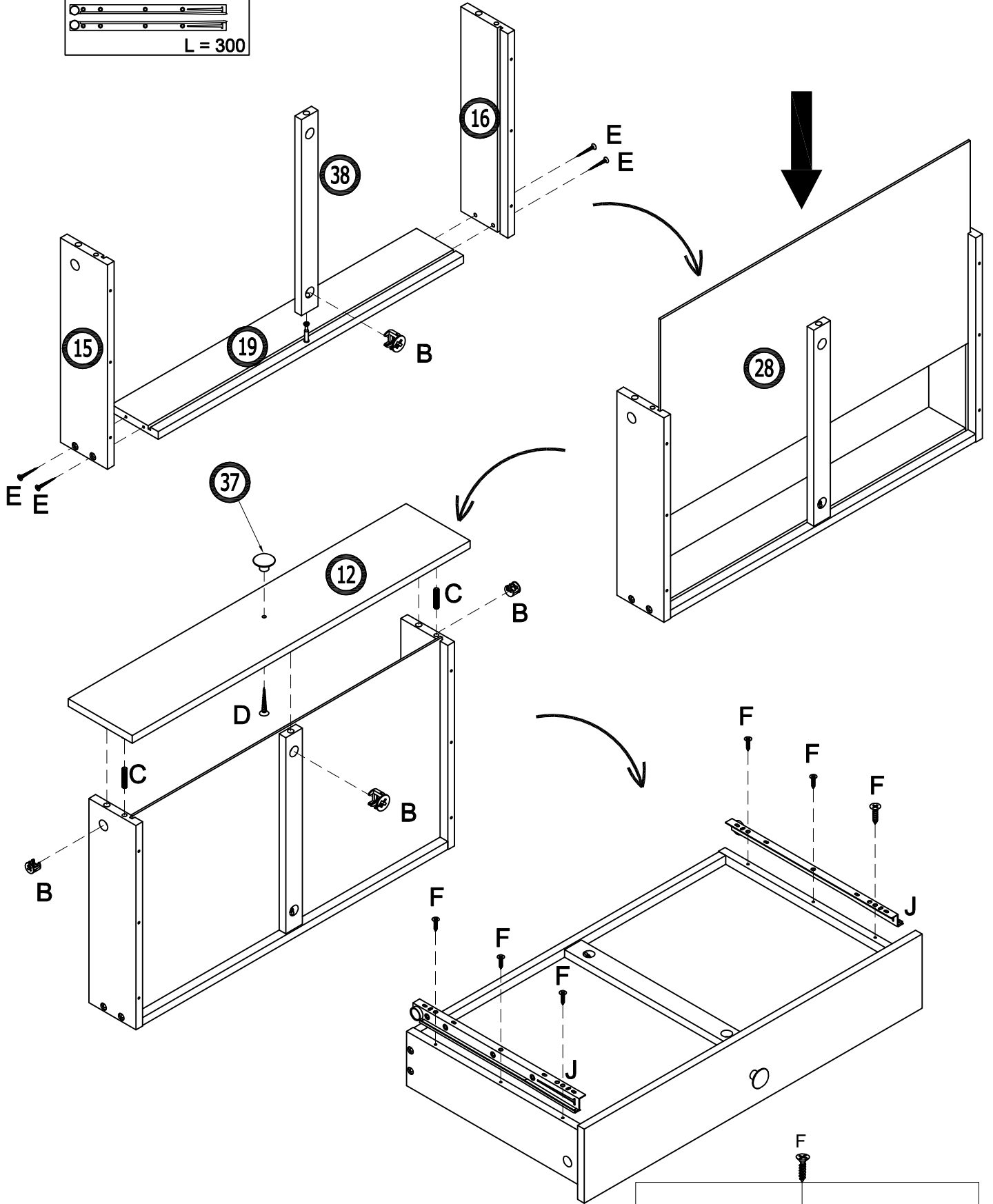
16

B x4  Ø14.5*9.5	C x2  Ø6*30	D x1  Ø4*25	E x4  Ø4*30	F x6  Ø3.6*11
J x2  L = 300				



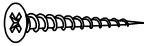

17

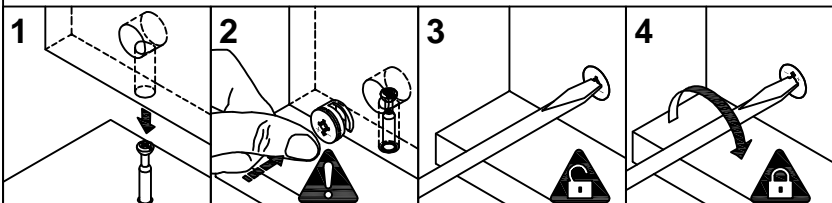
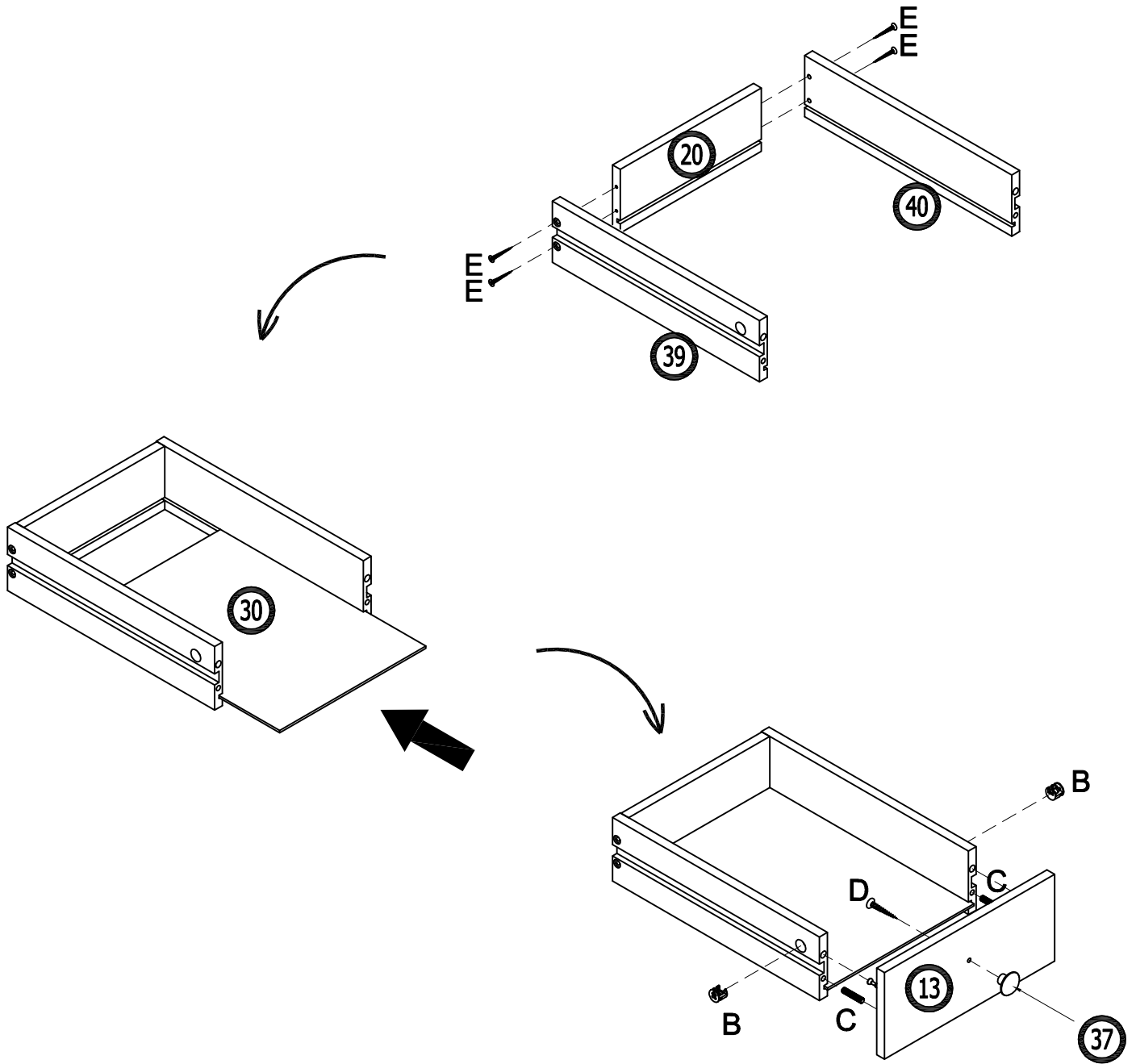
B	x 2	C	x 2	D	x 1	E	x 4
							
	Ø14.5*9.5		Ø6*30		Ø4*25		Ø4*30

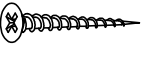
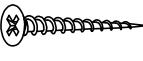

18

B	x 4	C	x 2	D	x 1	E	x 4
							
	Ø14.5*9.5		Ø6*30		Ø4*25		Ø4*30

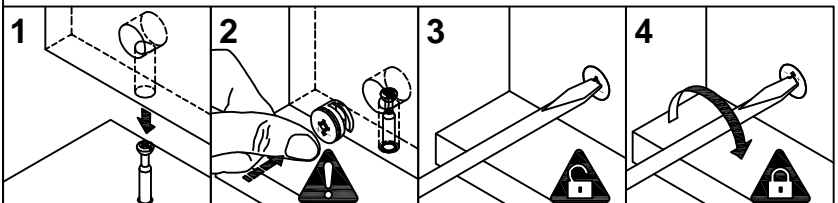
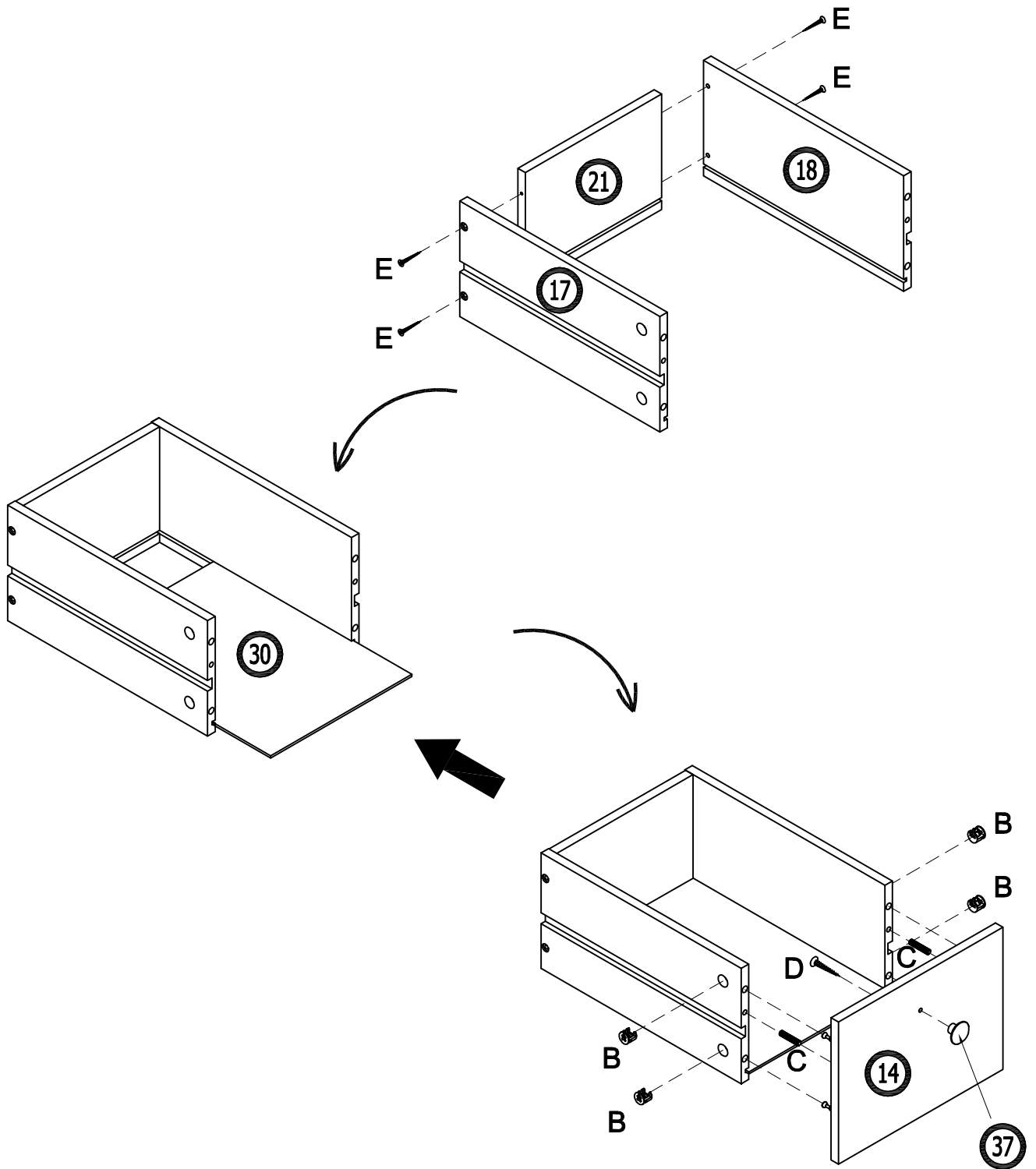

19

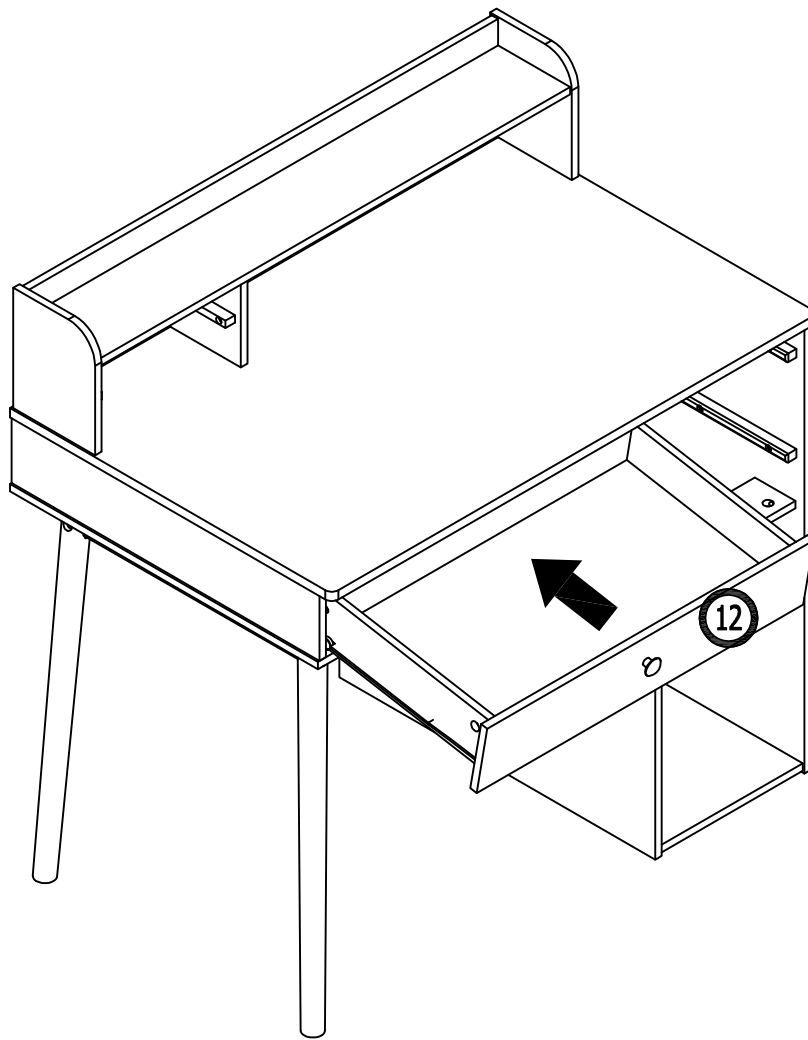
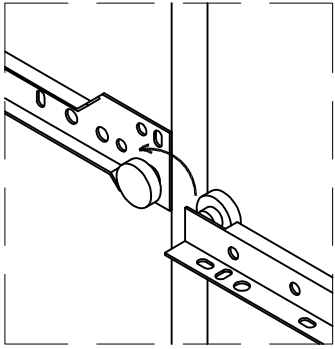

20

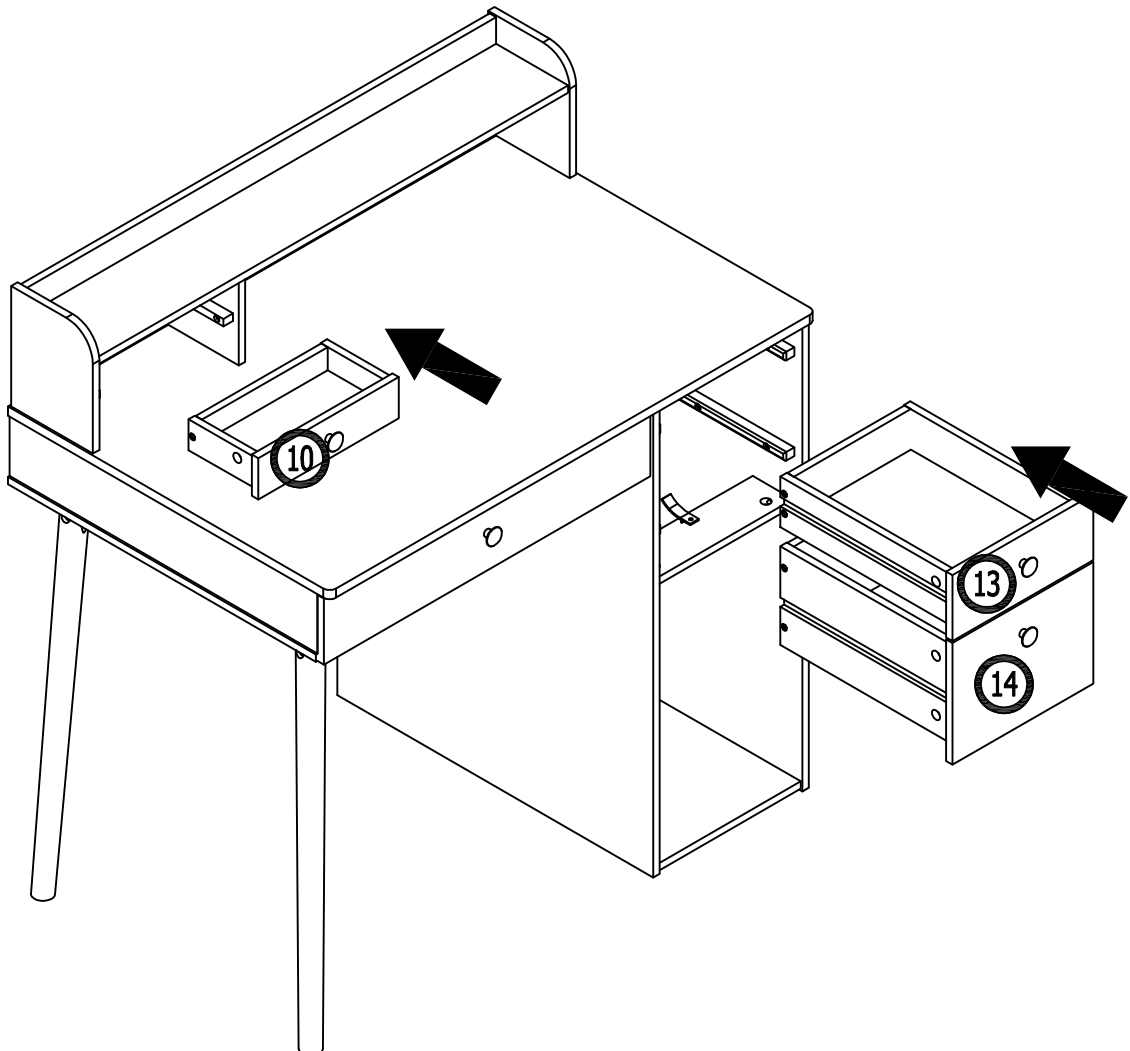

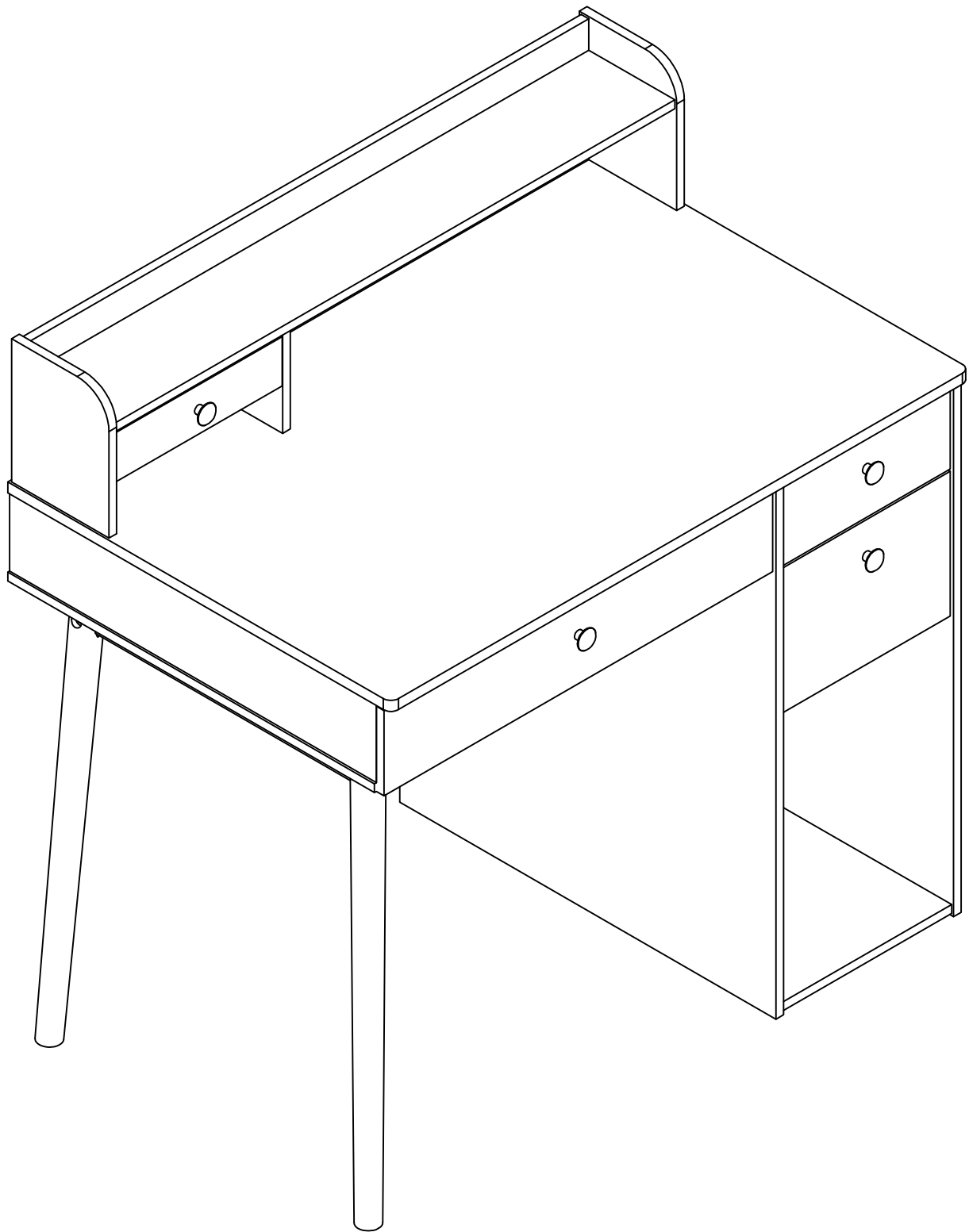

FR-Importé par / EN- Imported by / PT-importado por / ES-importado por / DE-Importiert von /
IT-Importato da / NL-Geïmporteerd door :

UE/EU : Vertbaudet SAS - 216, Rue Winoc Chocqueel, 59200 Tourcoing , France

UK : Vertbaudet UK Limited - Elder House, St Georges Business Park, 207 Brooklands Road,
Weybridge, Surrey KT13 0TS

